

# CONDUCTOR CABLES

and Fittings



# GENERAL

CONTENTS	Page	Page
General	2-5	Rondoflex-rubber sheathed screened  15
PVC flat cables	5, 6	PCV control cables
PVC-flat cables in Sonderausführung oder mit Abschirmung	7	with 2 tension relief cores  16
Polychloroprene (Neoprene) flat cables to DIN VDE 0250-UL-file E 113313	8	Neoprene control cables with tension relief cores  17
Polychloroprene (Neoprene) flat cables with copper wire -EMV-qualified	9	Cable glands   18,19
Rubber sheathed	10	Components for cable glands   19
Tough rubber sheathed (K)	11	Accessories, cable connectors   20
Cordaflex (SMK) rubber sheathed	12	Cable combination connector for flat and round cables   21
Optoflex - rubber sheathed	13	Terminal clamps and components   22
Rondoflex - rubber sheathed	14	Terminal boxes   23
		Questionnaire 24
		Pictures 9, 16, 26, 27

This catalog contains information on flexible conductor cable up to 1000 Volt rating and all fittings mainly used for our

- cable tenders
- cable carriers
- spring cable reels
- motor cable reels
- catalog 10c
- catalog 8a, 8b, 8c, 8d and 8e
- catalog 9a
- catalog 9b

Our experts will be pleased to recommend the best suitable cable for your application and your detailed inquiry using the questionnaire on page 26 of this catalog would be highly appreciated.

Cables for medium and high voltage ratings and special designs are also available. Please consult the factory.

Cable dimensions comply with VDE regulations and other international standards.

Actual cable dimensions and international or local safety requirements have to be considered for the design and layout of the cable carrying and guiding equipment.

The listed current-carrying capacities refer to:

- max. 4 simultaneously loaded conductors of multi-core cables
- ambient temperature + 30° C
- continuous duty
- stretched laying
- no grouping of cables

## Minimum bending radius for cables as per VDE 0298, part 3, table 3: (2006-6)

Application	Nominal voltage up to 1000 V			
	diameter of round cables or thickness of flat cables (d) in mm			
	up to 8 mm	from 8 to 12 mm	from 12 to 20 mm	over 20 mm
cable carriers	3 d	4 d	5 d	5 d
cable reels	5 d	5 d	5 d	6 d
cable tenders or guiding devices	7,5 d	7,5 d	7,5 d	7,5 d
unsupported and for connections	3 d	4 d	5 d	5 d
straigh installation	3 d	3 d	4 d	4 d



## 1. Determination of ampacity

### a) Rated currents and starting currents of motors

Table 1:

Nominal output	Three-phase cage rotor (1500 U/min, 50 Hz)											Direct current motor			
	Efficiency	Power factorsn		current								Efficiency	current		
		$\cos \varphi_N$	$\cos \varphi_A$	230 V		400 V		500 V		660 V			110 V	220 V	440 V
P	$\eta$			$I_N$	$I_A$	$I_N$	$I_A$	$I_N$	$I_A$	$I_N$	$I_A$	$\eta$	$I_N$	$I_N$	$I_N$
kW	%			A	A	A	A	A	A	A	A	%	A	A	A
0,75	74,5	0,78	0,76	3,2	14,4	1,8	8,1	1,5	6,8	1,1	5	75	9,2	4,6	2,3
1,1	75	0,81	0,76	4,3	19,8	2,5	11,5	2	9,2	1,5	6,9	75	13,5	6,8	3,3
1,5	77	0,82	0,76	5,8	27,3	3,3	15,5	2,6	12,2	2	9,4	77	17,2	8,7	4,4
2,2	80	0,82	0,73	8,2	39,4	4,7	22,6	3,7	17,8	2,9	14	78	27	13,3	6,7
3	80	0,79	0,73	11,1	54,4	6,4	31,4	5	24,5	3,5	17,2	80	34	17	8,5
4	82	0,84	0,73	14,6	73	8,4	42	6,4	32	4,9	24,5	80	45	22	11
5,5	83	0,85	0,65	19,6	100	11,3	57,6	8,6	43,9	6,7	34,2	84	61	30	15,5
7,5	85	0,86	0,65	25,8	134,2	14,8	77	11,5	59,8	9	46,8	85	82	41	21
11	87	0,86	0,60	36,9	195,6	21,2	112,4	17	90,1	13	68,9	86	120	60	30
15	87	0,86	0,60	50	270	29	156,6	22,5	121,5	17,5	94,5	87	160	81	41
18,5	88	0,86	0,60	61	335,5	35	192,5	27	148,5	21	115,5	88	195	97	49
22	89	0,87	0,60	71	398	41	230	32	179	25	140	89	232	116	58
30	90	0,87	0,60	96	547	55	314	43	245	33	188	89	315	155	78
37	90	0,87	0,60	119	690	68	394	54	313	42	244	89	384	190	96
45	91	0,88	0,60	141	832	81	478	64	378	49	289	90	462	230	116
55	91	0,88	0,60	172	–	99	594	78	468	60	360	91	–	282	140
75	91	0,88	0,60	235	–	135	826	106	647	82	500	92	–	280	190
90	92	0,88	0,60	279	–	160	992	127	787	98	608	93	–	–	225
110	92	0,88	0,60	341	–	196	–	154	970	118	743	93	–	–	277
132	92	0,88	0,60	409	–	235	–	182	–	140	896	93	–	–	330
160	93	0,88	0,60	491	–	282	–	220	–	170	–	93	–	–	–

This table shows typical running values which should only be used if there are no other manufacturers instructions.

Directions: Rated current:  $I_N$  Cage rotor motors:  $X = 6$   $I_A = X \cdot I_N$   
 Starting current:  $I_A$  Slipring rotor motors:  $X = 2$   
 Frequency regulated drives:  $X = 1,1^{(1)}$   
 DC motors:  $X = 2$

The starting currents resp. starting factors for squirrel cage motors do apply for direct net termination, only. If you do not find the required motor output in this table use formula as per section 1.

### b) Calculation of nominal current ( $I_N$ ), if only the output ( $P_N$ ) of the accommodative drive is known and not shown in the a.m. table.

For three-phase drive: 
$$I_N = \frac{P_N [\text{kW}] \cdot 1000}{\sqrt{3} \cdot U [\text{V}] \cdot \cos \varphi_N \cdot \eta}$$

Approximately:

For DC motors: 
$$I_N = \frac{P_N [\text{kW}] \cdot 1000}{U [\text{V}] \cdot \eta}$$

$\cos \varphi_N = 0,85$   
 $\eta = 0,85$  (efficiency)

For AC motors: 
$$I_N = \frac{P_N [\text{kW}] \cdot 1000}{U [\text{V}] \cdot \cos \varphi_N \cdot b}$$

<sup>(1)</sup> With frequency controlled devices we presume the use of input chokes.



## 2. Cable selection for intermittent periodic duty motor operation

a) According to the nominal current  $I_N$  select the cable cross section from the corresponding cable tables (pages 6 to 17)

b) De-rating factors  $f_1$  for intermittent periodic duty:

cross section [mm <sup>2</sup> ]	Factors ( $f_1$ ) for intermittent periodic duty with ED			
	60 %	40 %	25 %	15 %
1,5	1,00	1,00	1,00	1,00
2,5	1,00	1,00	1,04	1,07
4	1,00	1,03	1,05	1,19
6	1,00	1,04	1,013	1,27
10	1,03	1,09	1,21	1,44
16	1,07	1,16	1,34	1,62
25	1,10	1,23	1,46	1,79
35	1,13	1,28	1,53	1,90
50	1,16	1,34	1,62	2,03
70	1,18	1,38	1,69	2,13
95	1,20	1,42	1,74	2,21
120	1,21	1,44	1,78	2,26
150	1,22	1,46	1,81	2,30
185	1,23	1,48	1,82	2,32
240	1,23	1,49	1,85	2,36
300	1,23	1,50	1,87	2,39

c) De-rating factors  $f_2$  for varying ambient temperatures see DIN VDE 0298, part 4

Insulating Material	Rubber	PVC	Special compound
max. operation temperature	60 °C	70 °C	90 °C
Ambient temperature °C	Korrekturfaktor $f_2$		
10	1,29	1,22	1,15
15	1,22	1,17	1,12
20	1,15	1,12	1,08
25	1,08	1,06	1,04
30	1,00	1,00	1,00
35	0,91	0,94	0,96
40	0,82	0,87	0,91
45	0,71	0,79	0,87
50	0,58	0,71	0,82
55	0,41	0,61	0,76
60	-	0,50	0,71
65	-	0,35	0,65
70	-	-	0,58
75	-	-	0,50
80	-	-	0,41
85	-	-	0,29
90	-	-	-

d) De-rating factors  $f_3$  for multi-core cables see DIN VDE 0298, part 4 to 10 mm<sup>2</sup>

number of loaded cores	5	7	10	14	19	24	40	61
de-rating factor $f_3$	0,75	0,65	0,55	0,5	0,45	0,4	0,35	0,30

Number of loaded cores <5:  $f_3 = 1$

e) De-rating factors for dependence of current capacity referring to quantity of layers as per DIN VDE 0298 part 4, for cable carriers  $f_4 = 1$

(1) also valid for monospiral wrap

Quantity of layers LZ on reeler	1 <sup>(1)</sup>	2	3	4	5
De-rating factor $f_4$	0,80	0,61	0,49	0,42	0,38

f) Permissible cable ampacity under consideration of operation condition

$$I_{zul} = I_{max} \cdot f_1 \cdot f_2 \cdot f_3 \cdot f_4$$

Remark: The installation condition has not been considered (cable festoon system  $\approx 1$ , for cable reels see cat. No. 9b)  $I_{max}$  as per tables pages 6 to 17

g) Revision of cross section selected under 2a:

$$I_N \leq I_{zul}$$

$I_N$  = nominal current

$I_{zul}$  = permissible cable ampacity under consideration of operation conditions

h) If the a. m. condition are not met under 2g, repeat steps 2a to 2f with changed cross section.



### 3. Voltage Drop calculation for starting current

- a) If not specified by others a voltage drop of max. 3 % of the nominal voltage can be considered as standard value. In case this value is exceeded a reduction of the voltage drop is achieved by increasing the cross section. If the a. m. measure is insufficient booster cables have to be used. If the a.m. arrangements don't suffice, has the voltage drop to be reduced with a parallel connection of the busbar.
- b) If the nominal current  $I_N$  has been determined as per table No. 1 check voltage drop by using the figures for starting current  $I_A$ .
- c) Determination of max. starting current of the installation ( $I_A$ ), if nominal current has been calculated as per 1b. For starting current use x-fold the nominal current according to the used motor type (see 1a, table 1)

$$I_A = I_N \cdot X$$

d) Voltage drop

For three-phase current:

$$\Delta U = \sqrt{3} \cdot I \cdot I_A \cdot Z$$

For alternating current:

$$\Delta U = 2 \cdot I \cdot I_A \cdot Z$$

For direct current:

$$\Delta U = 2 \cdot I \cdot I_A \cdot R$$

Z = Impedance [ $\Omega$ /km]

R = Resistance [ $\Omega$ /km]

I = Feed length [km]

$I_A$  = Starting current in amps

Table 7: Effective Resistance

Cross section [mm <sup>2</sup> ]	Z for three-phase or AL Current cos $\varphi = 0,6, f = 50$ Hz [ $\Omega$ /km]	Z for frequency controlled drives cos $\varphi = 0,95, f = 50$ Hz [ $\Omega$ /km]	R for DC Current [ $\Omega$ /km]
1,5	8,7700	13,8000	14,4700
2,5	5,3100	8,3100	8,7100
4	3,3600	5,2100	5,4500
6	2,2500	3,4700	3,6200
10	1,3700	2,0800	2,1600
16	0,8880	1,3200	1,3600
25	0,5870	0,8470	0,8630
35	0,4430	0,6220	0,6270
50	0,3440	0,4660	0,4630
70	0,2580	0,3310	0,3210
95	0,2050	0,2460	0,2310
120	0,1740	0,2000	0,1830
150	0,1540	0,1680	0,1498
185	0,1360	0,1390	0,1180
240	0,1190	0,1120	0,0901
300	0,1080	0,0954	0,0718

### PVC-Flat cables for Cable Carriers

#### Application

Power and control cables for cranes and material handling equipment, machine tools etc. associated with medium mechanical stresses and frequent bending during operation in one plane only; for dry, humid or wet room application.

#### Technical Data

Temperature range: - 10 °C to + 70 °C  
 Maximum permissible operating temperature: + 70 °C  
 Nominal voltage  $U_0/U$ : 450/750 V

Type	Number & size of conductors [mm <sup>2</sup> ]	Outside dimensions height x width		Capacity max. at 30 °C <sup>(1)</sup> $I_{max}$ [A]	metric cable glands		Weight [kg/m]	Order-No.
		Maß min. [mm]	Maß max. [mm]		PVC	Brass		
HO7VH6-F	4 G 1,5	4,9 x 14,5	5,2 x 15,5	18	M 25x1,5-1	M 20x1,5	0,150	332 490
	8 G 1,5	4,9 x 27,0	5,2 x 28,5	18	M 50x1,5-1	M 40x1,5-2	0,295	332 491
	12 G 1,5	4,9 x 39,5	5,2 x 41,5	18	M 63x1,5-1	M 50x1,5-2	0,415	332 492
	4 G 2,5	5,6 x 18,0	5,9 x 19,0	26	M 32x1,5-1	M 25x1,5-2	0,210	332 493
	8 G 2,5	5,6 x 33,7	5,9 x 35,7	26	M 50x1,5-2	M 50x1,5-2	0,405	332 494
	12 G 2,5	5,6 x 49,5	5,9 x 52,0	26	M 63x1,5-2	M 63x1,5-2	0,610	332 495
	4 G 4	6,8 x 21,0	7,1 x 22,0	34	M 40x1,5-1	M 32x1,5-2	0,300	332 496
	4 G 6	7,5 x 24,0	7,8 x 25,0	44	M 40x1,5-1	M 32x1,5-2	0,385	332 497
	4 G 10	9,4 x 30,0	9,9 x 31,5	61	M 50x1,5-1	M 40x1,5-2	0,620	332 498
	4 G 16	10,7 x 34,5	11,2 x 36,5	82	M 50x1,5-2	M 50x1,5-2	0,970	332 499

<sup>(1)</sup> De-rating factors are not considered (refer to cable selection on page 4).



# PVC FLAT CABLES

Application: Cable Carriers



## Application

Power and control cables for cranes and material handling equipment, machine tools etc. associated with medium mechanical stresses and frequent bending during operation in one plane only; for dry, humid or wet room application.

## Technical Data

Temperature range: - 20 °C to + 60 °C  
 Maximum permissible operating temperature: + 70 °C  
 Nominal voltage  $U_0/U$ : H05VVH6-F 300/500 V  
 H07VVH6-F 450/750 V

Type	Number % size of conductors [mm <sup>2</sup> ]	Outside dimensions height x width max. [mm]	Capacity max. at 30 °C <sup>(1)</sup> I <sub>max</sub> [A]	metrical Flat cable glands		Weight [kg/m]	Order-No.
				PVC	Brass		
<b>H05VVH6-F</b>	24 G 1	4,6 x 70,0	15	-	-	0,600	332 081
<b>H07VVH6-F</b>	4 G 1,5	5,2 x 15,0	18	M 25x1,5-1	M 20x1,5	0,150	331 353
	4 X 1,5	5,2 x 15,0		M 25x1,5-1	M 20x1,5	0,150	330 230
	5 G 1,5	5,2 x 17,9		M 32x1,5-1	M 25x1,5-2	0,180	332 080
	7 G 1,5	5,2 x 25,8		M 40x1,5-1	M 32x1,5-2	0,260	331 481
	8 G 1,5	5,2 x 28,3		M 50x1,5-1	M 40x1,5-2	0,300	331 354
	8 X 1,5	5,2 x 28,3		M 50x1,5-1	M 40x1,5-2	0,300	331 724
	10 G 1,5	5,2 x 34,6		M 50x1,5-2	M 50x1,5-2	0,360	335 060
	10 X 1,5 <sup>(2)</sup>	5,2 x 34,6		M 50x1,5-2	M 50x1,5-2	0,360	332 083
	12 G 1,5	5,2 x 40,5		M 63x1,5-1	M 50x1,5-2	0,420	331 355
	12 X 1,5	5,2 x 40,5		M 63x1,5-1	M 50x1,5-2	0,420	331 707
	13 G 1,5 <sup>(2)</sup>	5,2 x 49,5	M 63x1,5-1	M 63x1,5-1	0,430	332 084	
	24 G 1,5	5,2 x 85,0	-	-	0,820	332 625	
	4 G 2,5	6,0 x 18,2	26	M 32x1,5-1	M 25x1,5-2	0,210	331 356
	5 G 2,5	6,0 x 21,8		M 40x1,5-1	M 32x1,5-2	0,260	332 100
	7 G 2,5	6,0 x 32,0		M 50x1,5-1	M 40x1,5-2	0,380	332 110
	8 G 2,5	6,0 x 34,2		M 50x1,5-2	M 50x1,5-2	0,405	331 357
	10 G 2,5	5,9 x 45,2		M 63x1,5-1	M 63x1,5-1	0,505	331 643
	12 G 2,5	6,0 x 50,0		M 63x1,5-1	M 63x1,5-1	0,620	331 358
	24 G 2,5	5,9 x 105,0		-	-	1,220	331 641
	4 G 4	6,9 x 20,8		34	M 40x1,5-1	M 32x1,5-2	0,300
5 G 4	6,9 x 25,1	M 40x1,5-1	M 32x1,5-2		0,390	331 364	
7 G 4	6,9 x 36,5	M 50x1,5-2	M 50x1,5-2		0,550	331 365	
4 G 6	7,4 x 22,8	44	M 40x1,5-1	M 32x1,5-2	0,385	331 360	
	5 G 6		7,4 x 27,5	M 50x1,5-1	M 40x1,5-2	0,530	331 366
	7 G 6		7,4 x 46,0	M 63x1,5-1	M 63x1,5-1	0,750	331 367
4 G 10	9,2 x 28,8	61	M 50x1,5-1	M 40x1,5-2	0,620	331 361	
	5 G 10		9,2 x 34,8	M 50x1,5-2	M 50x1,5-2	1,120	332 085
4 G 16	11,2 x 36,6	82	M 50x1,5-2	M 50x1,5-2	0,990	331 362	
	5 G 16		11,2 x 46,0	M 63x1,5-1	M 50x1,5-2	1,200	331 487
<b>AO7VVH6-F</b>	4 G 25	13,2 x 41,8	108	M 63x1,5-1	M 50x1,5-2	1,550	331 363
	5 G 25 <sup>(2)</sup>	16,0 x 56,0		-	-	1,730	332 086
<b>(H) O7VVH6-F</b>	4 G 35	14,9 x 50,2	135	-	-	2,030	331 773
	4 G 50	16,5 x 55,0	168	-	-	2,650	331 853
	4 G 70	18,4 x 62,8	207	-	-	3,650	331 785
	4 G 95	20,8 x 72,5	250	-	-	4,550	332 087

<sup>(1)</sup> De-rating factors are not considered (2. Selection of cables, page 4)

<sup>(2)</sup> Consult factory for delivery time



# PVC FLAT CABLES for Cable Carriers

## special Type or with Shielding



### Application

Power and control cables for cranes and material handling equipment, machine tools etc. associated with medium mechanical stresses and frequent bending during operation in one plane only; for dry, humid or wet room application.

### Technical Data

Temperature range: - 25 °C to + 70 °C  
 Maximum permissible operating temperature: + 70 °C  
 Nominal voltage  $U_0/U$ :  $\geq 1 \text{ mm}^2 = 300/500 \text{ V}$   
 $0,5 \text{ mm}^2 = 350 \text{ V}$

Type	Number & size of conductors [mm <sup>2</sup> ]	Description	Outside dimensions height x width [max. mm]	Capacity max. at 30 °C <sup>(1)</sup> I <sub>max</sub> [A]	metric Flat cable glands		Weight [kg/m]	Order-No.
					PVC	Brass		
YFLY-J	7 x 3 x 1	3 cores common shielding	10,3 x 50	15	M 63x1,5-1	M 63x1,5-1	0,710	331 968
	14 x 3 x 1		10,3 x 100		-	-	1,420	332 098
YFLY-O	7 x 4 x 0,5	4 cores common shielding	10,3 x 50	2,5	M 63x1,5-1	M 63x1,5-1	0,675	332 101
	14 x 4 x 0,5		10,3 x 100		-	-	1,350	332 102

Type	Number & size of conductors [mm <sup>2</sup> ]	Description	Outside dimensions height x width [max. mm]	Capacity max. at 30 °C <sup>(1)</sup> I <sub>max</sub> [A]	metric Flat cable glands		Weight [kg/m]	Order-No.
					PVC	Brass		
YCFLY-O	5 x 0,5	Individually shielded cores	4,7 x 21,0	2,5	M 32x1,5-1	M 25x1,5-2	0,140	331 655
	4 x 1		5,4 x 15,6	15	M 25x1,5-1	M 20x1,5-2	0,131	332 623
	4 x 1,5		6,3 x 19,6	18	M 32x1,5-1	M 25x1,5-2	0,210	331 976
	8 x 1,5		6,3 x 37,1		M 50x1,5-1	M 40x1,5-2	0,400	332 055
	12 x 1,5		6,3 x 53,5		M 63x1,5-1	M 63x1,5-1	0,610	331 829
YCFLY-J	8 x 1,5		6,3 x 37,1	26	M 50x1,5-1	M 40x1,5-2	0,400	331 918
	4 x 2,5		7,4 x 22,0		M 32x1,5-1	M 25x1,5-2	0,270	332 103
	6 x 2,5		8,5 x 39,0	34	M 50x1,5-2	M 50x1,5-2	0,410	332 104
	4 x 4		8,1 x 24,4	44	M 40x1,5-1	M 32x1,5-2	0,400	332 105
	4 x 6		9,8 x 31,6	61	M 50x1,5-1	M 40x1,5-2	0,520	332 106
	4 x 10		11,1 x 37,3	82	M 50x1,5-2	M 50x1,5-2	0,840	332 107
	4 x 16		13,1 x 42,7	108	M 63x1,5-1	M 63x1,5-1	1,280	332 099
	4 x 25		15 x 50	135	-	-	1,800	332 521
	4 x 35		16 x 55	168	-	-	2,300	332 435
YFLCY-O	7 x 2 x 0,75 PiC		2 cores common shielding	10,3 x 50,0	12	M 63x1,5-1	M 63x1,5-1	0,750
	14 x 2 x 0,75 PiC	10,3 x 100,0		M 63x1,5-1		M 63x1,5-1	1,500	332 108
YFLCY-O	5 x 4 x 0,5	4 cores common shielding	7,2 x 37,4	2,5	M 50x1,5-2	M 50x1,5-2	0,439	332 074
	7 x 4 x 0,5		10,3 x 50,0		M 63x1,5-1	M 63x1,5-1	0,745	331 923
	14 x 4 x 0,5		10,3 x 100,0		-	-	1,490	332 109
YFLCY-JZ	8 x 7 x 0,5	7 cores common shielding	12,5 x 71,0		-	-	1,180	331 370
	4 x 4 x 1	4 cores common shielding	11,5 x 35,0	15	M 50x1,5-2	M 50x1,5-2	0,625	331 371
YFLCY-J	7 x 3 x 1	3 cores common shielding	10,3 x 50,0		M 63x1,5-1	M 63x1,5-1	0,755	331 979
YFLCY-JJ	14 x 3 x 1	3 cores common shielding	10,3 x 100,0		-	-	1,510	331 909

<sup>(1)</sup> De-rating factors are not considered (2. Selection of cables, page 4).



# POLYCHLOROPRENE (NEOPRENE) FLAT CABLES

to DIN VDE 0250-UL-file E 113313 for Cable Carriers



## Application

Power and control cables for cranes and material handling equipment, machine tools etc. associated with medium mechanical stresses and frequent bending during operation in one plane only; for dry, humid or wet room application.

## Technical Data

Temperature range: - 25 °C to + 85 °C  
 Maximum permissible operating Temperature: + 90 °C  
 Nominal voltage  $U_0/U$ : 300/500 V

Type	Number & size of conductors [mm <sup>2</sup> ]	Outside dimensions height x width max. min [mm]	Capacity max. at 30 °C <sup>(1)</sup> I <sub>max</sub> [A]	metric Flat cable glands		Weight [kg/m]	Order-No.
				PVC	Brass		
NGFLGÖU-J	4 x 1,5	6,4 x 17,0	18	M 32x1,5-1	M 25x1,5-2	0,220	331 373
	5 x 1,5	6,4 x 21,5		M 40x1,5-1	M 32x1,5-2	0,240	330 660
	7 x 1,5	6,4 x 29,1		M 50x1,5-1	M 40x1,5-2	0,300	330 670
	8 x 1,5	6,4 x 32,0		M 50x1,5-1	M 40x1,5-2	0,400	331 374
	10 x 1,5	7,0 x 40,7		M 50x1,5-2	M 50x1,5-2	0,600	331 375
	12 x 1,5	7,0 x 47,7		M 63x1,5-1	M 63x1,5-1	0,630	331 376
	6 x 4 x 1,5	13,5 x 59,4		-	-	1,050	332 088
	4 x 2,5	7,8 x 20,7	26	M 32x1,5-1	M 25x1,5-2	0,290	330 680
	5 x 2,5	7,8 x 26,0		M 40x1,5-1	M 32x1,5-2	0,340	330 690
	7 x 2,5	7,8 x 33,0		M 50x1,5-1	M 40x1,5-2	0,540	330 700
	8 x 2,5	7,8 x 38,0		M 50x1,5-2	M 50x1,5-2	0,585	330 710
	10 x 2,5	8,1 x 47,0		M 63x1,5-1	M 63x1,5-1	0,680	331 378
	12 x 2,5	8,2 x 54,8		M 63x1,5-2	M 63x1,5-2	0,870	330 720
	6 x 4 x 2,5	17,0 x 71,0		-	-	2,376	332 089
	4 x 4	9,1 x 24,8	34	M 40x1,5-1	M 32x1,5-2	0,470	331 380
	5 x 4	9,0 x 32,0		M 50x1,5-1	M 40x1,5-2	0,520	331 381
	7 x 4	9,1 x 39,8		M 63x1,5-1	M 50x1,5-2	0,820	331 401
	4 x 6	9,9 x 27,9	44	M 40x1,5-1	M 40x1,5-2	0,620	330 730
	5 x 6	9,9 x 34,7		M 50x1,5-1	M 40x1,5-2	0,750	331 382
	7 x 6	9,9 x 45,9		M 63x1,5-1	M 63x1,5-1	0,920	331 402
	4 x 10	11,2 x 33,3	61	M50x1,5-1	M 40x1,5-2	0,960	330 740
	5 x 10 <sup>(2)</sup>	11,2 x 41,5		M 63x1,5-1	M 50x1,5-2	1,200	331 383
	7 x 10	11,2 x 55,3		M 63x1,5-2	M 63x1,5-2	1,520	331 403
	4 x 16	13,0 x 38,7	82	M 63x1,5-1	M 63x1,5-1	1,350	330 750
	5 x 16 <sup>(2)</sup>	13,0 x 50,0		M 63x1,5-1	M 63x1,5-1	1,410	331 384
	7 x 16	14,0 x 66,0		-	-	2,020	331 678
	4 x 25	14,7 x 46,0	108	M 63x1,5-1	M 63x1,5-1	2,400	330 760
	5 x 25 <sup>(2)</sup>	15,5 x 60,3		-	-	2,200	331 385
	7 x 25	16,5 x 79,0		-	-	3,240	331 386
	4 x 35	17,6 x 53,2	135	-	-	2,720	330 770
	7 x 35	18,2 x 91,0		-	-	4,600	331 388
	4 x 50	20,1 x 62,0	168	-	-	3,100	331 389
4 x 70	23,0 x 71,0	207	-	-	4,150	331 390	
4 x 95	25,5 x 81,0	250	-	-	5,210	331 391	
GFLGÖU-J	4 x 120	28,0 x 91,0	292	-	-	6,110	331 392

<sup>(1)</sup> De-rating factors are not considered (2. Selection of cables, page 4).

<sup>(2)</sup> Consult factory for delivery time.





# POLYCHLOROPRENE (NEOPRENE) FLAT CABLES

with copper wire -EMV- qualified for Cable Carriers



## Application

Power and control cables for cranes and material handling equipment, machine tools etc. associated with medium mechanical stresses and frequent bending during operation in one plane only; for dry, humid or wet room application.

## Technical Data

Temperature range: - 25 °C to + 80 °C  
 Maximum permissible operating Temperature: + 90 °C  
 Nominal voltage  $U_0/U$ : 300/500 V

Type	Number & size of conductors [mm <sup>2</sup> ]	Description	Outside-dimensions height x width [max. mm]	Capacity max. at 30 °C <sup>(1)</sup> I <sub>max</sub> [A]	metric Flat cable grands		Weight [kg/m]	Order-No.
					PVC	Brass		
GCFLGÖU-J	4 x 1,5	individually shield cores	8,0 x 22,5	18	M 40x1,5-1	M 32x1,5-2	0,291	332 138
	8 x 1,5		8,0 x 41,4		M 63x1,5-1	M 63x1,5-1	0,537	332 139
	10 x 1,5 <sup>(2)</sup>		7,5 x 45		M 63x1,5-1	M 63x1,5-1	0,720	332 176
	12 x 1,5		8,0 x 59,8		M 63x1,5-2	M 63x1,5-2	0,795	332 141
	4 x 2,5		8,6 x 24,2	26	M 40x1,5-1	M 32x1,5-2	0,437	332 142
	6 x 2,5		8,6 x 33,8		M 50x1,5-2	M 50x1,5-2	0,562	332 143
	12 x 2,5		8,6 x 65,1		-	-	1,004	332 144
	4 x 4		9,1 x 26,3		M 50x1,5-1	M 40x1,5-2	0,493	332 145
	4 x 6		9,8 x 29,1	44	M 50x1,5-1	M 40x1,5-2	0,603	332 146
	4 x 10		11,7 x 35,4	61	M 50x1,5-2	M 50x1,5-2	0,946	332 147
	4 x 16		13,5 x 41,1	82	M 63x1,5-1	M 63x1,5-1	1,320	332 148
	GCFLGÖU-O		4 x 1,5	individually shield cores	7,4 x 19,5	18	M 32x1,5-1	M 25x1,5-2
8 x 1,5		7,4 x 37,8	M 50x1,5-2		M 50x1,5-2		0,510	332 151
12 x 1,5		8,0 x 55,6	M 63x1,5-2		M 63x1,5-2		0,820	332 152
GFLCGÖU-O	4 x (2 x 1) C	shielded pairs	11,4 x 33,8	15	M 50x1,5-1	M 40x1,5-2	0,663	332 153
	6 x (2 x 2,5) C <sup>(2)</sup>		16,0 x 65	26	-	-	1,800	332 154



Vahle Cable Festooning System

<sup>(1)</sup> De-rating factors are not considered (2. Selection of cables, page 4).

<sup>(2)</sup> Consult factory for delivery time.



# RUBBER SHEATHED ROUND CABLES

## for Cable Carriers and Cable Reels with Low Duty Operation



### Application

Power and control cable with medium mechanical stresses for dry, humid or wet rooms and for outdoor application.

### Technical Data

Temperature range: - 30 °C to + 60 °C  
 Maximum permissible operating Temperature: + 60 °C  
 Nominal voltage  $U_0/U$ : 450/750 V

Type	Number & size of conductors [mm <sup>2</sup> ]	Outside Dimensions ca. [mm]	Capacity max. at 30 °C <sup>(1)</sup> I <sub>max</sub> [A]	Weight [kg/m]	Order-No.
HO7RN-F	1 x 1,5	6,5	24	0,059	332 177
	1 x 2,5	7,0	32	0,074	331 996
	1 x 4	8,0	42	0,101	331 867
	1 x 6	9,0	54	0,129	331 667
	1 x 10	10,0	73	0,202	332 230
	1 x 16	12,0	98	0,279	332 240
	1 x 25	13,5	129	0,407	332 250
	1 x 35	15,5	158	0,540	332 260
	1 x 50	18,0	198	0,740	332 270
	1 x 70	19,5	245	0,980	332 280
	1 x 95	22,5	292	1,260	332 290
	1 x 120	24,5	344	1,560	332 300
	1 x 150	27,0	391	1,920	332 310
	1 x 185	29,5	448	2,300	331 473
	1 x 240	33,0	528	2,960	332 178
	1 x 300	36,0	608	3,610	332 179
	3 G 1,5	10,0	18	0,154	331 407
	3 G 2,5	11,5	26	0,229	331 408
	3 G 4	13,5	34	0,319	331 409
	3 G 6	15,5	44	0,420	331 410
	3 G 10	21,0	61	0,770	331 411
	3 G 16	24,5	82	1,060	331 412
	4 G 1,5	11,0	18	0,192	330 250
	4 G 2,5	13,0	26	0,279	330 260
	4 G 4	15,0	34	0,388	330 270
	4 G 6	17,0	44	0,520	330 280
	4 G 10	22,5	61	0,930	330 290
	4 G 16	27,0	82	1,300	330 300
	4 G 25	31,5	108	1,880	330 310
	4 G 35	35,5	135	2,450	330 320
	4 G 50	41,0	168	3,380	330 330
	4 G 70	45,5	207	4,450	332 150
	4 G 95	52,5	250	5,830	331 413
	4 G 120	57,0	292	7,100	332 181
	4 G 150	65,0	335	8,319	332 182
	4 G 185	69,5	382	10,062	332 183
	5 G 1,5	12,0	18	0,233	332 160
	5 G 2,5	14,0	26	0,335	332 170
	5 G 4	16,5	34	0,477	332 180
	5 G 6	19,0	44	0,640	332 190
	5 G 10	25,0	61	1,130	332 200
	5 G 16	29,5	82	1,600	332 210
5 G 25	35,0	108	2,310	332 220	
5 G 35	45,8	135	2,684	331 929	
7 G 1,5	15,5	18	0,370	331 414	
7 G 2,5	18,5	26	0,530	331 415	
8 G 2,5	19,5	26	0,590	330 340	
12 G 1,5	22,4	18	0,507	331 416	
19 G 1,5	24,0	18	0,788	332 082	
12 G 2,5	22,0	26	0,770	330 350	
18 G 2,5	26,5	26	1,090	330 360	
24 G 1,5	28,0	18	0,968	331 418	
24 G 2,5	30,5	26	1,430	330 370	
3 x 1,5	10,0	18	0,154	332 320	
3 x 2,5	11,5	26	0,229	332 330	
3 x 4	13,5	34	0,319	332 340	
3 x 6	15,5	44	0,422	332 350	
3 x 10	21,0	61	0,770	332 360	
3 x 16	24,5	82	1,060	332 370	



# TOUGH RUBBER SHEATHED ROUND CABLES (K)

for Cable Reels, Cable-Guiding Devices and Cable Carriers



## Application

Power and control cable with high mechanical stresses and frequent bending during operation; for dry, humid or wet rooms and for outdoor application.

## Technical Data

Temperature range: - 25 °C to + 80 °C  
 Maximum permissible operating temperature: + 90 °C  
 Nominal voltage  $U_0/U$ : 0,6/1kV

Type	Number & size of conductors [mm <sup>2</sup> ]	Outside Dimensions [ca. mm]	Capacity max. at 30 °C <sup>(1)</sup> $I_{max}$ [A]	Weight [kg/m]	Order-No.
NSHTÖU-J	4 x 1,5	14,0	23	0,235	332 017
	5 x 1,5	15,0		0,276	332 018
	7 x 1,5	17,6		0,420	332 019
	12 x 1,5	21,3		0,625	332 021
	18 x 1,5	24,5		0,830	332 022
	24 x 1,5	28,0		1,080	332 023
	30 x 1,5	29,5		1,190	332 024
	42 x 1,5	35,0		1,733	332 184
	4 x 2,5	17,0	30	0,350	332 026
	5 x 2,5	18,0		0,410	332 027
	7 x 2,5	20,8		0,515	332 028
	12 x 2,5	24,4		0,840	332 029
	18 x 2,5	28,2		1,195	332 030
	24 x 2,5	33,0		1,570	332 031
	30 x 2,5	34,5		1,750	332 032
	4 x 4	19,0	41	0,490	332 034
	4 x 6	20,5	53	0,610	332 035
	4 x 10	24,7	74	0,940	332 036
	4 x 16	29,1	99	1,305	332 037
	4 x 25	34,4	130	1,950	332 038
	4 x 35	38,6	161	2,710	332 039
	4 x 50	45,0	202	3,790	332 002
	4 x 70	49,0	250	4,550	332 041
4 x 95	58,0	300	6,080	332 042	
4 x 120	63,0	352	7,420	332 043	
4 x 150	66,5	404	8,905	332 044	

## Composite cables, cores unshielded and shielded

NSHTÖU-J	19 x 2,5 + 5 x 1,5 (C) <sup>(2)</sup>	33,8	30/23	1,570	332 046
	25 x 2,5 + 5 x 1,5 (C) <sup>(2)</sup>	35,0	30/23	1,740	332 045

## Flexible power cables, three-core design with splitted earth conductor

NSHTÖU-J	3 x 70 + 3 x 35/3 <sup>(2)</sup>	45,0	250	3,960	332 155
	3 x 95 + 3 x 50/3 <sup>(2)</sup>	52,0	300	5,330	332 156

<sup>(1)</sup> De-rating factors are not considered (2. Selection of cables, page 4).

<sup>(2)</sup> Consult factory for delivery time.



# CORDAFLEX (SMK) RUBBER SHEATHED ROUND CABLES

for Cable Reels, Cable-Guiding Devices and Cable Carriers



## Application

Power and control cable with very high mechanical stresses and frequent bending during operation; for dry, humid or wet rooms and for outdoor application.

## Technical Data

Temperature rang: - 35 °C to + 60 °C  
 Maximum permissible operating temperature: + 90 °C  
 Nominal voltage  $U_0/U$ : 0,6/1kV

Type	Number & size of conductors [mm <sup>2</sup> ]	O. D.		Capacity max. at 30 °C <sup>(1)</sup> I <sub>max</sub> [A]	Weight [kg/m]	Order-No.
		min. [mm]	max. [mm]			
(N)SHTÖU-J	4 x 1,5 <sup>(2)</sup>	12,2	13,8	23	0,240	332 309
	5 x 1,5	13,0	14,6		0,280	332 311
	7 x 1,5	15,2	17,2		0,385	332 312
	12 x 1,5	21,4	23,4		0,710	332 313
	18 x 1,5	21,3	23,3		0,760	332 314
	24 x 1,5	23,8	26,8		0,990	332 315
	30 x 1,5 <sup>(2)</sup>	26,6	29,6		1,220	332 316
	36 x 1,5 <sup>(2)</sup>	26,5	29,5		1,260	332 317
	44 x 1,5 <sup>(2)</sup>	29,5	32,5		1,530	332 318
	56 x 1,5 <sup>(2)</sup>	34,9	37,9		2,050	332 319
	4 x 2,5	13,2	14,8	30	0,305	332 321
	5 x 2,5	14,2	15,8		0,355	332 322
	7 x 2,5	16,6	18,6		0,510	332 323
	12 x 2,5	23,4	25,4		0,920	332 324
	18 x 2,5	23,3	25,3		1,005	332 325
	24 x 2,5	26,2	29,2		1,320	332 326
	30 x 2,5	29,4	32,4		1,660	332 327
	36 x 2,5	29,3	32,3		1,720	332 328
	44 x 2,5	34,1	37,1		2,230	332 329
	56 x 2,5 <sup>(2)</sup>	40,1	43,1		2,940	332 331
	4 x 4	16,0	18,0	41	0,455	332 291
	5 x 4	17,4	19,4		0,430	332 296
	4 x 6	17,4	19,4	53	0,575	332 292
	5 x 6	19,0	21,0		0,690	332 297
	4 x 10	21,6	23,6	74	0,905	332 293
	5 x 10	23,4	25,4		1,080	332 298
	4 x 16	23,7	26,7		1,240	332 294
	5 x 16	26,1	29,1	99	1,500	332 299
	4 x 25	28,5	31,5		1,850	332 295

## Flexible power cables, three-core design with splitted earth conductor

(N)SHTÖU-J	3x 35+3x 16/3	28,5	31,5	162	2,160	332 301
	3x 50+3x 25/3	34,4	37,4	202	2,850	332 302
	3x 70+3x 35/3	39,7	42,7	250	3,920	332 303
	3x 95+3x 50/3	44,3	47,3	301	5,020	332 304
	3x120+3x 70/3	51,0	55,0	352	6,630	332 305
	3x150+3x 70/3	53,9	57,9	404	7,690	332 306
	3x185+3x 95/3 <sup>(2)</sup>	58,9	62,9	461	9,310	332 307
	3x240+3x120/3 <sup>(2)</sup>	67,4	71,4	540	12,200	332 308

## Control cables for horizontal payout with 20-kN tension relief

(N)SHTÖU-J	46 x 1 (20 kN)	26,6	29,6	18	1,190	332 332	
	24 x 2,5 (20 kN) <sup>(2)</sup>	26,2	29,2		30	1,290	332 333
	30 x 2,5 (20 kN)	29,4	32,4			1,610	332 334
	44 x 2,5 (20 kN)	34,1	37,1			2,160	332 335
	56 x 2,5 (20 kN) <sup>(2)</sup>	40,1	43,1			2,840	332 336

## Bus cables, twisted and shielded pairs

(N)SHTÖU-O	6 x (2 x 0,5) C <sup>(2)</sup>	23,1	25,1	2,5	0,885	332 337
	6 x (2 x 1,0) C	28,9	31,9	18,0	1,330	332 338

## Composite cables, cores unshielded and shielded

(N)SHTÖU-J	19 x 2,5 + 5 x 1 (C)	26,2	29,2	30/18	1,290	332 339
	25 x 2,5 + 5 x 1 (C)	29,4	32,4		1,620	332 341



# OPTOFLEX-RUBBER SHEATHED FIBRE-OPTIC CABLES

for Cable Reels (mono-spiral winding) Cable Carriers, Cable Tenders



## Application

For optical signal and data transmission on cranes and material handling equipment: suitable for forced guidance (e. g. reels, festoon systems, cable tenders) at high data rates, large bandwidth and absolute immunity to electromagnetic interference.

Unrestricted use indoors and outdoors, resistant to ozone and moisture.

## Technical Data

Operation temperature	- 20 °C to + 60 °C
Tensile load	max. 300 N
Torsional stress at entries	50°/m
Minimum bending radii	110 mm
fixed installation and on festoons	110 mm
on reels and cable tenders	250 mm
Minimum distances with S-type directional changes	50 x D (D = cable dia.)
Travel speed:	
- Gantry	up to 120 m/min. (mono-spiral winding reels only)
- Trolley	up to 240 m/min. (festoons, cable tenders)
- Hoist	not suitable

Type	Number & size of conductors [mm <sup>2</sup> ]	Outside Dimensions		Weight [kg/m]	Order-No.
		min. [mm]	max. [mm]		
OPTOFLEX	6G 62,5 / 125 Micron	14,9	16,9	0,240	331 792
	6G 50,0 / 125 Micron <sup>(1)</sup>				331 925

Further types on request

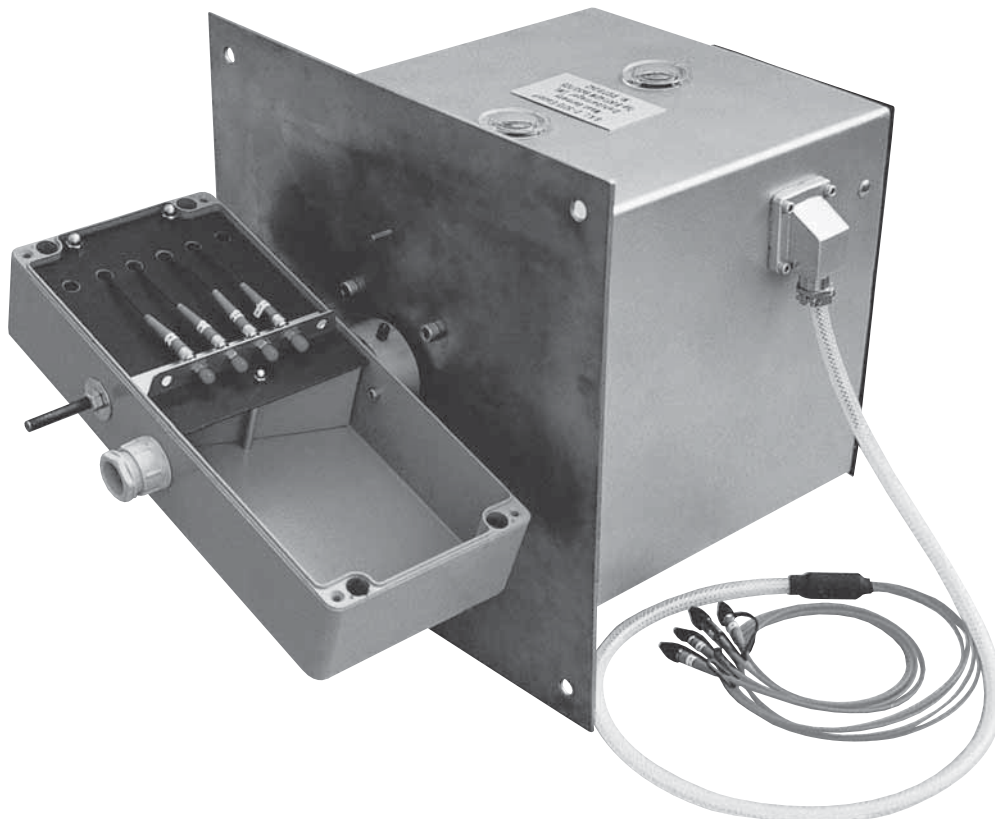

Rotary joint for fibre optics (in conjunction with slipping units on motor cable reels)

<sup>(1)</sup> Time of delivery on request.



# RONDoflex-RUBBER SHEATHED ROUND CABLES

## for Cable Carriers and Cable Reels



### Application

Power and control cable with high mechanical stresses and frequent bending during operation; for dry, humid or wet rooms and for outdoor application.

### Technical Data

Temperature range: - 35 °C to + 60 °C  
 Maximum permissible operating temperature: + 90 °C  
 Nominal voltage  $U_0/U$ : 0,6/1kV

Type	Number & size of conductors [mm <sup>2</sup> ]	Outside Dimensions		Capacity max. at 30 °C <sup>(1)</sup> I <sub>max</sub> : [A]	Weight [kg/m]	Order-No.
		min. [mm]	max. [mm]			
NGRDGÖU-O	1 x 35	12,3	13,9	162	0,430	331 914
	1 x 50	15,0	16,6	202	0,625	331 775
	1 x 70	16,5	18,5	250	0,835	331 869
	1 x 95	18,9	20,9	301	1,070	331 764
	1 x 120	20,8	22,8	352	1,340	331 836
	1 x 150	22,9	24,9	404	1,650	331 870
	1 x 185 <sup>(2)</sup>	24,8	27,8	461	2,010	331 847
NGRDGÖU-J	12 x 1,5 <sup>(2)</sup>	16,2	18,2	23	0,440	331 857
	18 x 1,5 <sup>(2)</sup>	18,7	20,7		0,615	331 856
	24 x 1,5	22,1	24,1		0,805	331 861
	30 x 1,5 <sup>(2)</sup>	23,3	25,3		0,930	332 122
	36 x 1,5 <sup>(2)</sup>	24,6	27,6		1,090	332 123
	12 x 2,5	17,9	19,9	30	0,580	331 860
	18 x 2,5	21,5	23,5		0,865	331 871
	24 x 2,5	24,0	27,0		1,110	331 778
	30 x 2,5	26,4	29,4		1,330	338 008
	36 x 2,5 <sup>(2)</sup>	28,4	31,4		1,550	332 124
	4 x 4	13,9	15,5	41	0,350	331 903
	5 x 4	15,7	17,7	53	0,450	331 902
	4 x 6	15,9	17,9		0,475	331 858
	5 x 6	17,5	19,5		0,575	331 777
	4 x 10	18,2	20,2	74	0,680	331 776
	5 x 10	20,8	22,8	99	0,865	331 765
	4 x 16	22,9	24,9		1,070	331 859
	5 x 16	24,6	27,6		1,300	331 872
	4 x 25	26,9	29,9	131	1,600	331 863
	5 x 25	29,5	32,5		1,940	331 848
4 x 35	30,1	33,1	2,090		331 873	
4 x 50	35,7	38,7	202	2,970	331 837	

### Flexible power cables, three-core design with splitted earth conductor

NGRDGÖU-J	3 x 35 + 3 x 16/3 <sup>(2)</sup>	27,7	30,7	162	1,800	332 363
	3 x 50 + 3 x 25/3 <sup>(2)</sup>	32,5	35,5	202	2,540	332 364
	3 x 70 + 3 x 35/3 <sup>(2)</sup>	39,1	42,1	250	3,570	332 365

### Bus cables, twisted and shielded pairs or individual shielding

NGRDGÖU-O	6 x (2 x 0,5) C	22,1	25,1	2,5	0,850	332 366
	9 x (2 x 0,5) C	28,3	31,3		1,340	332 367
	6 x (2 x 1) C	28,1	31,1	18	1,250	331 767
	9 x (2 x 1) C	35,9	38,9		2,010	331 779
	12 x 1 (C) <sup>(2)</sup>	18,0	20,0		0,590	331 784



# RONDOFLEX-RUBBER SHEATHED ROUND CABLES

shielded, for Cable Carriers



## Application

Cable festoon systems for any kind of material handling equipment, machine tools etc. associated with high mechanical stresses and frequent bending during operation, especially where interferences between power cables and data transmission cables are to be expected. The high quality rubber compound allows for indoor and outdoor operation.

## Technical Data

Temperature range: - 35 °C to + 60 °C  
 Maximum permissible operating temperature: + 90 °C  
 Nominal voltage  $U_0/U$ : 0,6/1kV

Type	Number & size of conductors [mm <sup>2</sup> ]	Cross Section [mm <sup>2</sup> ]			Outside Dimension [max. mm]	Capacity max. at 30 °C <sup>(1)</sup> I <sub>max</sub> [A]	Weight [kg/m]	Order-No.
		Power-conducto	Ground conductor	Shield				
NGRDGCGÖU-J	4 x 4	4	4	8	17,8	41	0,485	332 855
	4 x 6 <sup>(2)</sup>	6	6	10,7	20,2	53	0,700	332 856
	4 x 10	10	10	12,7	22,7	74	0,925	332 857
	3 x 16 + 3 x 2,5	16	7,5	13,3	25,2	99	1,150	332 858
	3 x 25 + 3 x 4	25	12	15,9	28,3	131	1,610	332 854
	3 x 35 + 3 x 6	35	18	21,4	32,3	162	2,160	332 859
	3 x 50 + 3 x 10	50	30	24,9	38,0	202	3,090	332 860
	3 x 70 + 3 x 10	70	30	29,8	43,9	250	4,100	332 861
	3 x 95 + 3 x 16	95	48	36,9	47,2	301	5,040	333058

## Cable construction

from 3x16 + 3x2,5 mm<sup>2</sup>

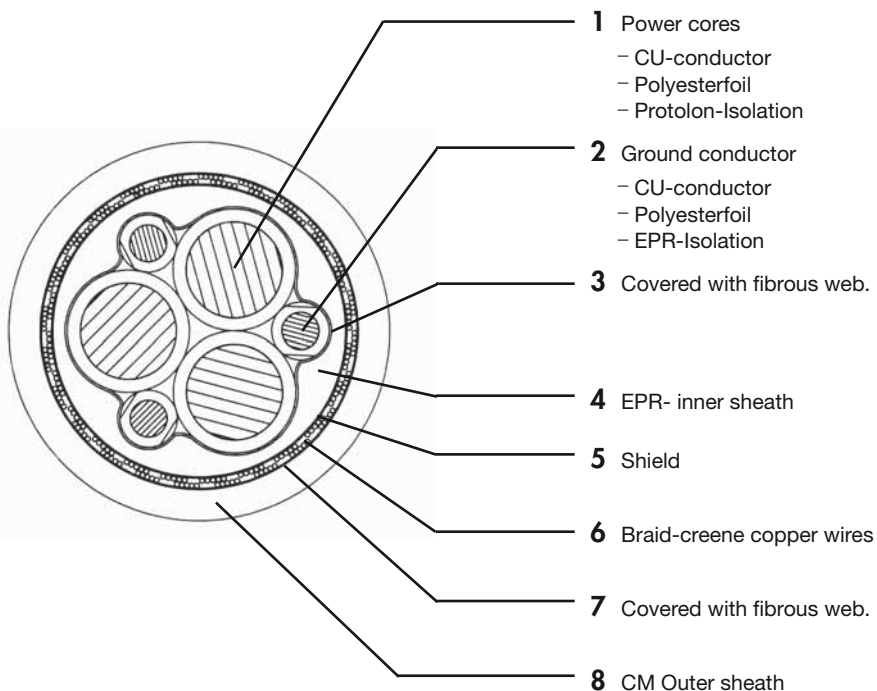

<sup>(1)</sup> De-rating factors are not considered (2. Selection of cables, page 4).

<sup>(2)</sup> Consult factory for delivery time.



# PVC CONTROL CABLES

## with 2 Steel tension Reliefs for Cable Carriers



### Application

Power and control cable for lifts and material handling equipment, control pendants, for dry and wet room and outdoors.

### Technical Data

Temperature ranger: - 5 °C to + 70 °C  
 Maximum permissible operating temperature: + 70 °C  
 Nominal voltage  $U_0/U$ : 300/500 V

Type	Number & size of conductors [mm <sup>2</sup> ]	O. D. [mm]	Capacity max. at 30 °C <sup>(1)</sup> $I_{max}$ [A]	Weight [kg/m]	Order-No.
lift cable 2TY	12 x 1	14,9 (27,3)	15	0,446	332 132
	18 x 1	17,0 (32,0)		0,528	331 939
	25 x 1	21,0 (36,0)		0,660	331 924
	30 x 1	21,9 (39,1)		0,760	332 133
	8 x 1,5	14,9 (27,3)	18	0,426	332 134
	12 x 1,5	16,5 (31,5)		0,505	331 992
	20 x 1,5	21,0 (36,0)		0,715	332 135
	24 x 1,5	22,6 (37,6)		0,820	332 136



VAHLE Cable Festooning System for Container Crane Electrification.





# NEOPRENE-CONTROL CABLES

with tension Relief for Cable Carriers



## Application

Power and control cable for lifts and material handling equipment, control pendants, for dry and wet room and outdoor.

## Technical Data

Temperature range: - 25 °C to + 80 °C  
 Maximum permissible operating temperature: + 80 °C  
 Nominal voltage  $U_0/U$ : 300/500 V

### Neoprene control cable with tension relief

Type	Number & size of conductors [mm <sup>2</sup> ]	Outside Dimension [ca. mm]	Capacity max. at 30 °C <sup>(1)</sup> $I_{max}$ [A]	Weight [kg/m]	Tension strength/ relief core [N]	Order-No.	
<b>STN</b>	7 x 1	13,5	15	0,255	2500	331 419	
	12 x 1	19,5		0,500	2500	331 420	
	18 x 1	20,0		0,570	1550	331 421	
	24 x 1	22,5		0,745	2500	331 422	
	36 x 1	27,0		1,060	2500	331 423	
	4 x 1,5	11,5	18	0,195	350	332 092	
	5 x 1,5	12,0		0,220	1000	331 424	
	7 x 1,5	13,5		0,295	2500	331 425	
	9 x 1,5	16,5		0,410	2500	332 093	
	12 x 1,5	21,0		0,575	2500	331 427	
	18 x 1,5	22,0		0,700	2500	331 428	
	24 x 1,5	25,0		0,940	2000	331 429	
	42 x 1,5	32,0		1,600	2500	331 430	
	4 x 2,5	12,5		26	0,265	250	332 094
	7 x 2,5	17,5			0,460	2500	332 095
	12 x 2,5	21,5	0,770		350	332 096	

### Neoprene control cable with tension relief and common screening

Type	Number & size of conductors [mm <sup>2</sup> ]	Outside Dimensions [ca. mm]	Capacity max. at 30 °C <sup>(1)</sup> $I_{max}$ [A]	Weight [kg/m]	Tension strength/ relief core [N]	Order-No.
<b>STCN</b>	6 x 0,5	11,0	2,5	0,140	1500	331 436
	6 x 0,75	11,5	12	0,170	1500	331 437
	4 x 1	11,5	15	0,150	250	331 431
	7 x 1	15,0		0,250	2500	331 432
	12 x 1	20,5		0,480	2500	331 433
	18 x 1	21,0		0,510	1500	331 434
	24 x 1	25,0		0,750	2500	331 435
	6 x 1,5	15,5	18	0,280	2100	331 438

<sup>(1)</sup> De-rating factors are not considered (2. Selection of cables, page 4).



# CABLE GLANDS



## Polycarbonate and brass glands for flat cables

Protection code IP 54

Conduit nuts to be ordered separately

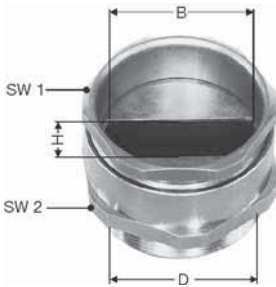

Thread D	PVC – Polyamid					Brass – nickel-plated				
	H mm	B mm	SW 1 mm	SW 2 mm	Order-No.	H mm	B mm	SW 1 mm	SW 2 mm	Order-No.
M 20 x 1,5	-	-	-	-	-	5	15	22	24	332 543
M 25 x 1,5-1	5	15	23	27	332 549	-	-	-	-	-
M 25 x 1,5-2	-	-	-	-	-	8	20	28	30	332 544
M 32 x 1,5-1	8	21	30	36	332 550	-	-	-	-	-
M 32 x 1,5-2	-	-	-	-	-	11,5	27	37	40	332 545
M 40 x 1,5-1	11,5	28	40	42	332 551	-	-	-	-	-
M 40 x 1,5-2	-	-	-	-	-	11,5	34	47	50	332 546
M 50 x 1,5-1	11,5	35	50	53	332 552	-	-	-	-	-
M 50 x 1,5-2	12	40	55	60	332 553	12	44	54	57	332 624
M 63 x 1,5-1	13	45	60	65	332 554	13	50	60	66	332 547
M 63 x 1,5-2	9	60	60	65	332 663	9	60	60	65	332 664

## Aluminium and brass glands for flat cables

Protection code 54



Conduit nuts to be ordered separately

Thread D	H	B	L	SW 1	Order-No.
	mm				
M 32 x 1,5/42	12	44	65	54	332 665
M 40 x 1,5/42	12	44	50	54	332 666
M 40 x 1,5/48-1	13	50	65	60	332 667
M 40 x 1,5/48-2	9	60	65	60	332 668

## Polycarbonate and brass glands for round cables

Protection code 55

Conduit nuts to be ordered separately



Thread D	PVC – Polyamid				Brass – nickel-plated			
	for cable-Ø mm range	SW 1 mm	SW 2 mm	Order-No.	or cable-Ø mm range	SW 1 mm	SW 2 mm	Order-No.
M 16 x 1,5	4- 9	16	19	332 697	6-12	18	20	332 687
M 20 x 1,5-1	6-11	19	22	332 537	6-12	18	22	332 688
M 20 x 1,5-2	6-13	21	24	332 538	8-13	20	22	332 689
M 25 x 1,5	6-15	23	27	332 539	7-15	22	27	332 690
M 25 x 1,5	9-19	30	32	332 530	9-19	28	30	332 691
M 32 x 1,5	17-26	40	42	332 531	17-27	37	40	332 692
M 40 x 1,5	17-27	40	42	332 698	17-28	37	43	332 693
M 50 x 1,5-1	23-34	50	53	332 536	23-33	47	55	332 694
M 50 x 1,5-2	29-40	55	60	332 532	29-39	54	57	332 695
M 63 x 1,5	35-45	60	65	332 540	35-46	60	65	332 696



# COMPONENTS FOR CABLE GLANDS



## Polycarbonate and brass glands with tension relief and bending protection for round cables

Conduit nuts to be ordered separately

Protection code IP 54



Thread D	PVC – Polyamid				Brass – nickel-plated			
	for cable-Ø mm range	B mm	SW 2 mm	Order-No.	for cable-Ø mm range	B mm	SW 2 mm	Order-No.
M 16 x 1,5	5,5-7,5	24	19	332 586	6-11,5	26	20	332 580
M 20 x 1,5-1	7,5-9,5	30	22	332 587	8-11,5	29	22	332 581
M 20 x 1,5-2	10-13	34	27	332 588	-	-	-	-
M 25 x 1,5-1	13-16,5	42	32	332 589	8,5-15	32	27	332 582
M 25 x 1,5-2	-	-	-	-	12-19	38	30	332 583
M 32 x 1,5	18-25	52	42	332 590	17-27	50	40	332 584
M 40 x 1,5	22-32	59	53	332 591	27-34	54	50	332 585

## Polycarbonate and brass glands for round cables

Conduit nuts to be ordered separately

Protection code IP 68



Thread D	PVC – Polyamid				Brass – nickel-plated			
	for cable-Ø mm range	SW 1 mm	SW 2 mm	Order-No.	for cable-Ø mm range	SW 1 mm	SW 2 mm	Order-No.
M 12 x 1,5	3- 6	15	15	332 679	3-6	14	14	332 592
M 16 x 1,5	5-10	20	20	332 680	5-9	17	17	332 593
M 20 x 1,5	8-13	24	24	332 681	9-13	22	22	332 594
M 25 x 1,5	11-17	29	29	332 682	11-16	27	27	332 595
M 32 x 1,5	15-21	36	36	332 683	14-21	34	34	332 596
M 40 x 1,5	19-28	46	46	332 684	19-27	43	43	332 597
M 50 x 1,5	27-35	55	55	332 685	24-35	55	55	332 598
M 63 x 1,5-1	32-42	68	68	332 686	32-42	65	65	332 599
M 63 x 1,5-2	-	-	-	-	38-48	65	65	332 678

### Conduit nuts GM

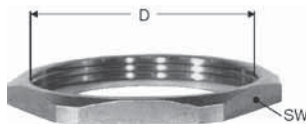

Thread D	PVC – Polyamid		Brass – nickel-plated	
	SW mm	Order-No.	SW mm	Order-No.
M 12x1,5	17	332 763	15	332 762
M 16x1,5	22	332 752	19	332 745
M 20x1,5	27	332 541	24	332 746
M 25x1,5	32	332 533	30	332 747
M 32x1,5	41	332 534	36	332 748
M 40x1,5	50	332 753	46	332 749
M 50x1,5	60	332 535	60	332 750
M 63x1,5	75	332 542	70	332 751

### Sealing Rings DM Material: Polyethylene



for Thread D	Order-No.
M 12x1,5	332 754
M 16x1,5	332 755
M 20x1,5	332 756
M 25x1,5	332 757
M 32x1,5	332 758
M 40x1,5	332 759
M 50x1,5	332 760
M 63x1,5	332 761

### Conduit Covers VM

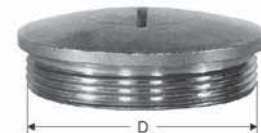

Thread D	Kunststoff Polyamid Order-No.	Brass - nickel-plated Order-No.
M 12x1,5	332 743	332 742
M 16x1,5	332 699	332 706
M 20x1,5	332 700	332 707
M 25x1,5	332 701	332 708
M 32x1,5	332 702	332709
M 40x1,5	332 703	332 710
M 50x1,5	332 704	332 711
M 63x1,5	332 705	332 712



# CABLE COMBINATION CONNECTOR

for flat and round Cables



## Reduction RM

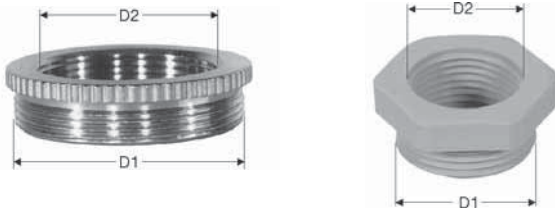

Thread D1	D2	PVC Polyamid Order-No.	Brass nickel-plated Order-No.
M 16x1,5	M 12x1,5	332 735	332 728
M 20x1,5	M 16x1,5	332 736	332 729
M 25x1,5	M 20x1,5	332 737	332 730
M 32x1,5	M 25x1,5	332 738	332 731
M 40x1,5	M 32x1,5	332 739	332 732
M 50x1,5	M 40x1,5	332 740	332 733
M 63x1,5	M 50x1,5	332 741	332 734

## Extension Fittings EM



Thread D1	D2	PVC Polyamid Order-No.	Brass nickel-plated Order-No.
M 12x1,5	M 16x1,5	332 721	332 714
M 16x1,5	M 20x1,5	332 722	332 715
M 20x1,5	M 25x1,5	332 723	332 716
M 25x1,5	M 32x1,5	332 724	332 717
M 32x1,5	M 40x1,5	332 725	332 718
M 40x1,5	M 50x1,5	332 726	332 719
M 50x1,5	M 63x1,5	332 727	332 720

## Extension Fittings EM

Material: Aluminium

Thread D	female Thread Pg	D <sub>A</sub>	D <sub>I</sub>	L	T	Order-No.
		mm				
M 32x1,5	Pg 42	57	24	65	15	332 669
M 40x1,5	Pg 42	57	32	50	15	332 670
M 40x1,5	Pg 48	64	32	65	16	332 671

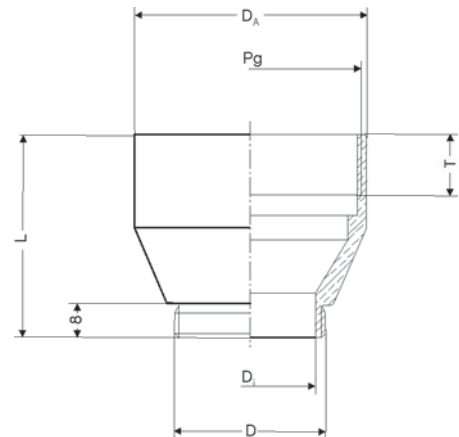

## Cable connectors for flat cables

Protection code IP 54

Cable connectors Type	B <sup>(1)</sup> mm	H <sup>(1)</sup> mm	Materials	Order-No.
VAC 66	66	11	housing of aluminium with Neoprene sealings and galvanized hardware	331 267
VAC 68	68	7		331 268
VAC 63	63	11		331 269
VAC 73	73	14		331 270
VAC 63	63	11		331 269

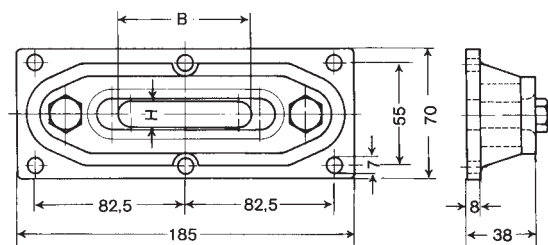

<sup>(1)</sup> Prepare cutout B and H if necessary and adapt it to flat cable measures.

For larger types of flat cables use combination connector FL 21 (page 21).



# CABLE COMBINATION CONNECTOR

for flat and round Cables

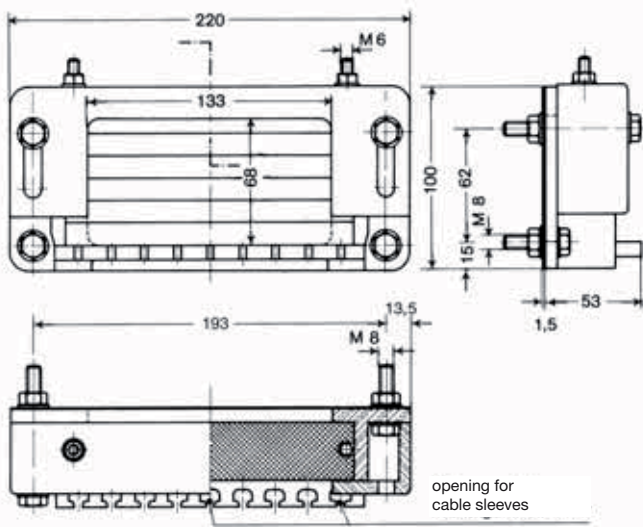

## Connector for flat and round cables

Protection code IP 54

Type	max. clamping capacity mm height x width	Material	Order-No.
FL 21	65 x 130	housing of aluminium with Neoprene sealings and galvanized hardware	331 241
Sealing Paste (sufficient for 2 connectors)			331 271

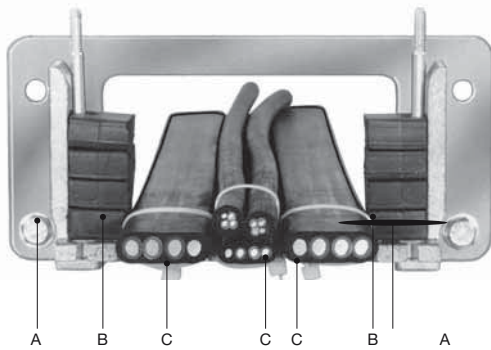

## Installation instruction

1. Bolt the connector-flange to the terminal box using M 8 (A) bolts.
2. The lateral rubber elements (B) to be cut and inserted to suit your cable package.
3. Install the cables using sealing paste to fill open space. Use cable sleeves (C) to keep the cable package in position.

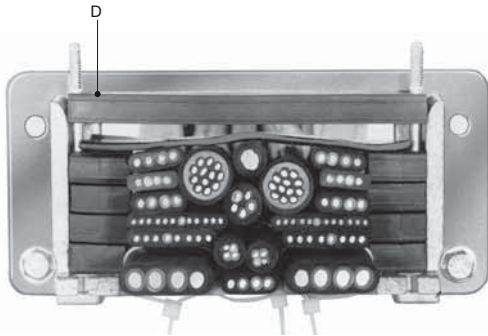

4. Flatten upper surface of cable package with sealing paste.
5. Fill in the remaining rubber elements (D).

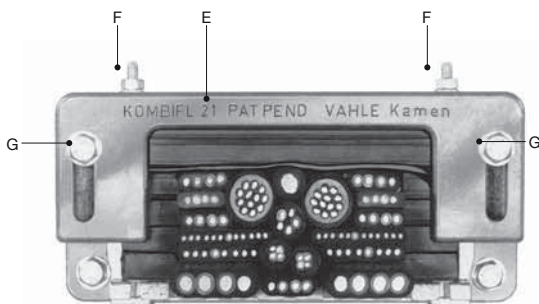

6. Affix cover (E) via M 6 (F) bolts hand tight.
7. Insert the upper, long bolts M 8 (G) and tighten slightly.
8. Tighten M 6 (F) nuts.
9. Tighten M 8 (G) bolts.
10. Cable sleeves (C) can be removed.





## Noryl Terminal Boxes

Cable glands and terminal clamps to be ordered separately.

Type	AK 0		AK 1		AK 2	
Material	Noryl					
Hardware	galvanized					
Protection code	IP 54					
Dimensions L x B x H mm	115 x 115 x 70		190 x 150 x 100		280 x 200 x 140	
Measure x	60		75		120	
Terminal Block BL mm	60		130		220	
Cable glands	max. No.		max. No.		max. No.	
	A-side	C-side	A-side	C-side	A-side	C-side
M 20x1,5	2	2	6	6	12	12
M 25x1,5	2	2	5	5	10	10
M 32x1,5	1	1	3	3	8	8
M 40x1,5	-	-	2	2	4	4
M 50x1,5	-	-	2	2	3	3
M 63x1,5	-	-	-	-	3	3
Weight kg	approx. 0,280		approx. 0,500		approx. 1,300	
Order-No.	316 333		310 310		315 180	

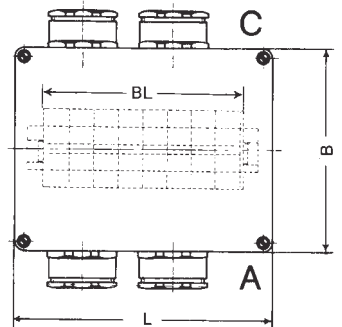
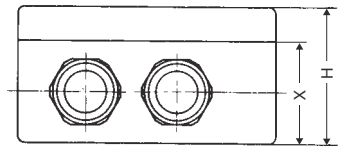

## Steel Terminal Boxes

Cable glands and terminal clamps to be ordered separately.

Type	AKST 1		AKST 2		AKST 3	
Material	steel					
Surface protection	two comp. paint DD/RAL 7032; hardware galv.					
Protection class	IP 65					
Dimensions L x B x H mm	200 x 150 x 120		300 x 200 x 120		400 x 200 x 120	
Measure x	90		90		90	
Terminal Block BL mm	160		260		360	
Cable glands	max. No.		max. No.		max. No.	
	A-side	C-side	A-side	C-side	A-side	C-side
M 20x1,5	10	10	18	18	22	22
M 25x1,5	10	10	14	14	20	20
M 32x1,5	5	5	9	9	10	10
M 40x1,5	3	3	5	5	7	7
M 50x1,5	2	2	4	4	5	5
M 63x1,5	2	2	3	3	4	4
Weight kg	approx. 2,100		approx. 2,950		approx. 3,720	
Order-No.	316 334		316 335		316 336	

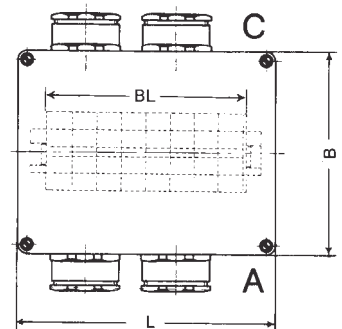
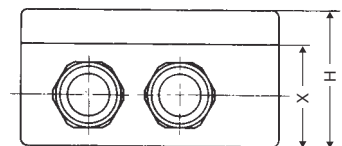



# QUESTIONNAIRE

To our nearest local agency:

Name and Address of customer: \_\_\_\_\_

Reference: \_\_\_\_\_

Date: \_\_\_\_\_

1. For which type of application will the cable be used? \_\_\_\_\_

2. Outdoors  \_\_\_\_\_ Indoors  \_\_\_\_\_

3. Temperature range \_\_\_\_\_ °C min. \_\_\_\_\_ °C max.

4. Is round or flatform cable required? \_\_\_\_\_

5. Which type of cable guiding or carrying equipment are you planning? \_\_\_\_\_

Cable Carrier  Cable Reel  Cable Tender  Other guiding device

6. Travelling speed \_\_\_\_\_ m/mm. Acceleration \_\_\_\_\_ m/s<sup>2</sup> or time of acceleration \_\_\_\_\_ s

7. Which power or ampacity to be carried simultaneously?

\_\_\_\_\_ kV \_\_\_\_\_ A

8. Operating voltage \_\_\_\_\_ V \_\_\_\_\_ Hz

9. Max. allowable voltage drop \_\_\_\_\_ V or \_\_\_\_\_ % for cable length \_\_\_\_\_ m

10. Required power and control cables \_\_\_\_\_

No. of cables	No. of conductors	Size of conductors [mm <sup>2</sup> ]	O. D. of round cable [mm]	Width x Thickness of flatform cables [mm]	Weight kg/m	Nominal current [A]	Starting current [A]

11. Can the number of conductors and the sizes be combined in one or in more cables? yes  no

12. Special operating conditions: \_\_\_\_\_

13. Further details: \_\_\_\_\_







## INSTALLATION PHOTOS



Motor driven VAHLE Cable Carriers, Hamburg Harbour



Frequency driven VAHLE Motor Reelers, container crane at Hamburg Harbour



Harbour view



VAHLE Motor Reelers and Festoon Systems, container cranes at Dunkirchen Harbour

## Products and Service

Catalog No.

<b>1 Open conductor systems</b>	
Open conductor systems	1a
<b>2 Insulated conductor systems</b>	
U 10	2a
FABA 100	2b
U 15 - U 25 - U 35	2c
U 20 - U 30 - U 40	2d
<b>3 Compact conductor systems</b>	
VKS 10	3a
VKS - VKL	3b
<b>4 Enclosed conductor systems</b>	
KBSL - KSL	4a
KBH	4b
MKH	4c
LSV - LSVG	4d
<b>5 Contactless power supply</b>	
Contactless power supply (CPS®)	5a
<b>6 Data transmission</b>	
VAHLE Powercom®	6a
Slotted Microwave Guide (SMG)	6b
<b>7 Positioning systems</b>	
VAHLE APOS®	7a
<b>8 Festoon systems and cables</b>	
Festoon systems for □- tracks	8a
Festoon systems for flat cables on I- tracks	8b
Festoon systems for round flat cables on I- tracks	8c
Festoon systems for ◇- tracks	8d
Cables	8e
<b>9 Reels</b>	
Spring operated cable reels	9a
Motor powered cable reels	9b
<b>10 Others</b>	
Battery charging systems	10a
Heavy enclosed conductor systems	10b
Tender	10c
Contact wire	10d

### Assemblies/Commissioning

### Spare parts/Maintenance service

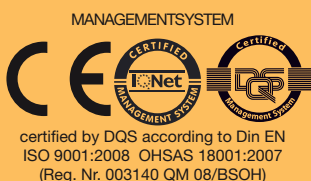

## Products and Service

Catalog No.

<b>1 Open conductor systems</b>	
Open conductor systems	1a
<b>2 Insulated conductor systems</b>	
U 10	2a
FABA 100	2b
U 15 - U 25 - U 35	2c
U 20 - U 30 - U 40	2d
<b>3 Compact conductor systems</b>	
VKS 10	3a
VKS - VKL	3b
<b>4 Enclosed conductor systems</b>	
KBSL - KSL - KSLT	4a
KBH	4b
MKH	4c
LSV - LSVG	4d
<b>5 Contactless power supply</b>	
Contactless power supply (CPS®)	5a
<b>6 Data transmission</b>	
VAHLE Powercom®	6a
Slotted Microwave Guide (SMG)	6b
<b>7 Positioning systems</b>	
VAHLE APOS®	7a
<b>8 Festoon systems and cables</b>	
Festoon systems for □- tracks	8a
Festoon systems for flat cables on I- tracks	8b
Festoon systems for round flat cables on I- tracks	8c
Festoon systems for ◇- tracks	8d
Cables	8e
<b>9 Reels</b>	
Spring operated cable reels	9a
Motor powered cable reels	9b
<b>10 Others</b>	
Battery charging systems	10a
Heavy enclosed conductor systems	10b
Tender	10c
Contact wire	10d

### Assemblies/Commissioning

### Spare parts/Maintenance service



certified by DQS according to Din EN  
ISO 9001:2008 OHSAS 18001:2007  
(Reg. Nr. 003140 QM 08/BSOH)



**POWERAIL LTD.**

WORKING FOR THE FUTURE WITH

Powerail Ltd. High Road, Finchley, London, N12 8PT,

Phone 020 8446 0350/1246 • Fax 020 8446 7054

E-mail: enquiries@powerailtld.com

**VAHLE**  
ELECTRIFICATION SYSTEMS

